

JVC

SCHEMATIC DIAGRAMS

COLOUR TELEVISION

AV-20F702

CD-ROM No.SML200109

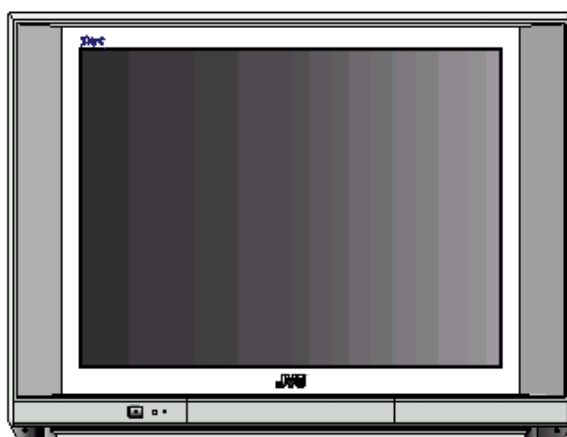

SEMICONDUCTOR BASE CONNECTIONS

DIODE

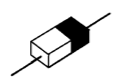

- 1SS133T-77
- AU02A-EIC
- HZ30-3L TD
- MTZJ11B T-77
- MTZJ12B T-77
- MTZJ27B T-77
- MTZJ5.1B T-77
- MTZJ5.6B T-77
- MTZJ6.2B T-77
- MTZJ9.1B T-77
- RS-4FS

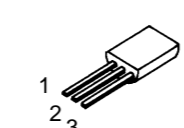
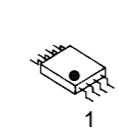
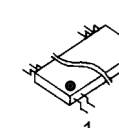
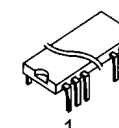

IC

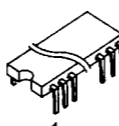

- OEC7055B
- TB1253N

- M62420SP
- MM1311AD

- AN5829S

- S-24C08ADPA-01

- NJM2150AM

- PST600C

- KIA7805API
- KIA7809API

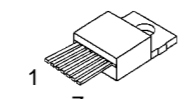
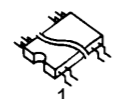
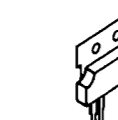
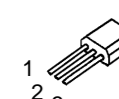
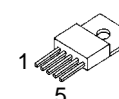

TRANSISTOR

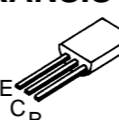

- STR-G6624

- KIA78L05BP-AT
- KIA78L12BP-AT

- AN5276

- TC90A53F

- LA78040

- 2SA1015Y(TPE2)
- 2SB926(S,T)-AA
- 2SC1815Y(TPE2)
- 2SC752(G)(TM)_Y
- 2SD734(E,F)-AA

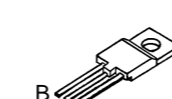
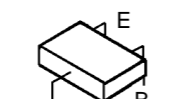
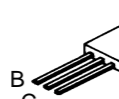
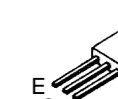
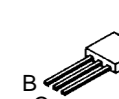
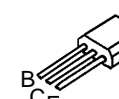

- 2SC1740SP TP

- 2SC4159(D,E)

- 2SC2621(D,E)-RAC

- 2SA1837
- 2SC4793

- 2SA1037AKT146R,S
- 2SC2412KT146 R,S
- 2SC2814(F3,F4)-T
- DTA144EKAT146
- DTC114EKAT146
- DTC114TKAT146

- 2SD2499(LBOEC1)

AV-20F702 STANDARD CIRCUIT DIAGRAM

NOTE ON USING CIRCUIT DIAGRAMS

1.SAFETY

The Components identified by the symbol Δ are critical for safety. For continued safety, replace safety critical components only with manufacturer's recommended parts.

2.INDICATION OF PARTS SYMBOL [EXAMPLE]

●In the PC board :R1209→R209

3.NOTE FOR REPAIRING SERVICE

This model's power circuit is partly different in the GND.

Please, care must be taken for the following points.

(1)Do not touch the LIVE side GND or the LIVE side GND and the ISOLATED(NEUTRAL) side GND simultaneously. If the above caution is not respected, an electric shock may be caused. Therefore, make sure that the power cord is surely removed from the receptacle when, for example, the chassis is pulled out.

(2)Do not short between the LIVE side GND and ISOLATED(NEUTRAL) side GND or never measure with a measuring apparatus (oscilloscope, etc.) the LIVE side GND and ISOLATED(NEUTRAL) side GND at the same time. If the above precaution is not respected , a fuse or any parts will be broken.

◇ Since the circuit diagram is a standard one, the circuit and circuit constants may be subject to change for improvement without any notice.

CONTENTS

- SEMICONDUCTOR BASE CONNECTIONS..... 2**
- BLOCK DIAGRAMS 3**
- CIRCUIT DIAGRAMS 5**
 - MAIN PCB MICON/TUNER SCHEMATIC DIAGRAM
 - MAIN PCB CHROMA/IF SCHEMATIC DIAGRAM
 - MAIN PCB DEFLECTION SCHEMATIC DIAGRAM
 - MAIN PCB POWER SCHEMATIC DIAGRAM
 - MAIN PCB SOUND SCHEMATIC DIAGRAM
 - MAIN PCB AV SCHEMATIC DIAGRAM
 - COMB FILTER PCB SCHEMATIC DIAGR
 - CRT/SVM PCB SCHEMATIC DIAGRAM
- PATTERN DIAGRAMS 21**
 - MAIN/ PCB PATTERN
 - COMB FILTER PCB PATTERN
 - CRT/SVM PCB PATTERN
- WAVEFORMS 27**

BLOCK DIAGRAM

- ◀ R.SIGNAL
- △ G.SIGNAL
- ▲ B.SIGNAL
- ↕ DEFLECTION SIGNAL
- ↕ AUDIO SIGNAL(REC)
- ↕ TUNER VIDEO SIGNAL
- ↕ RECORD LUMINANCE SIGNAL
- ↕ RECORD COLOR SIGNAL

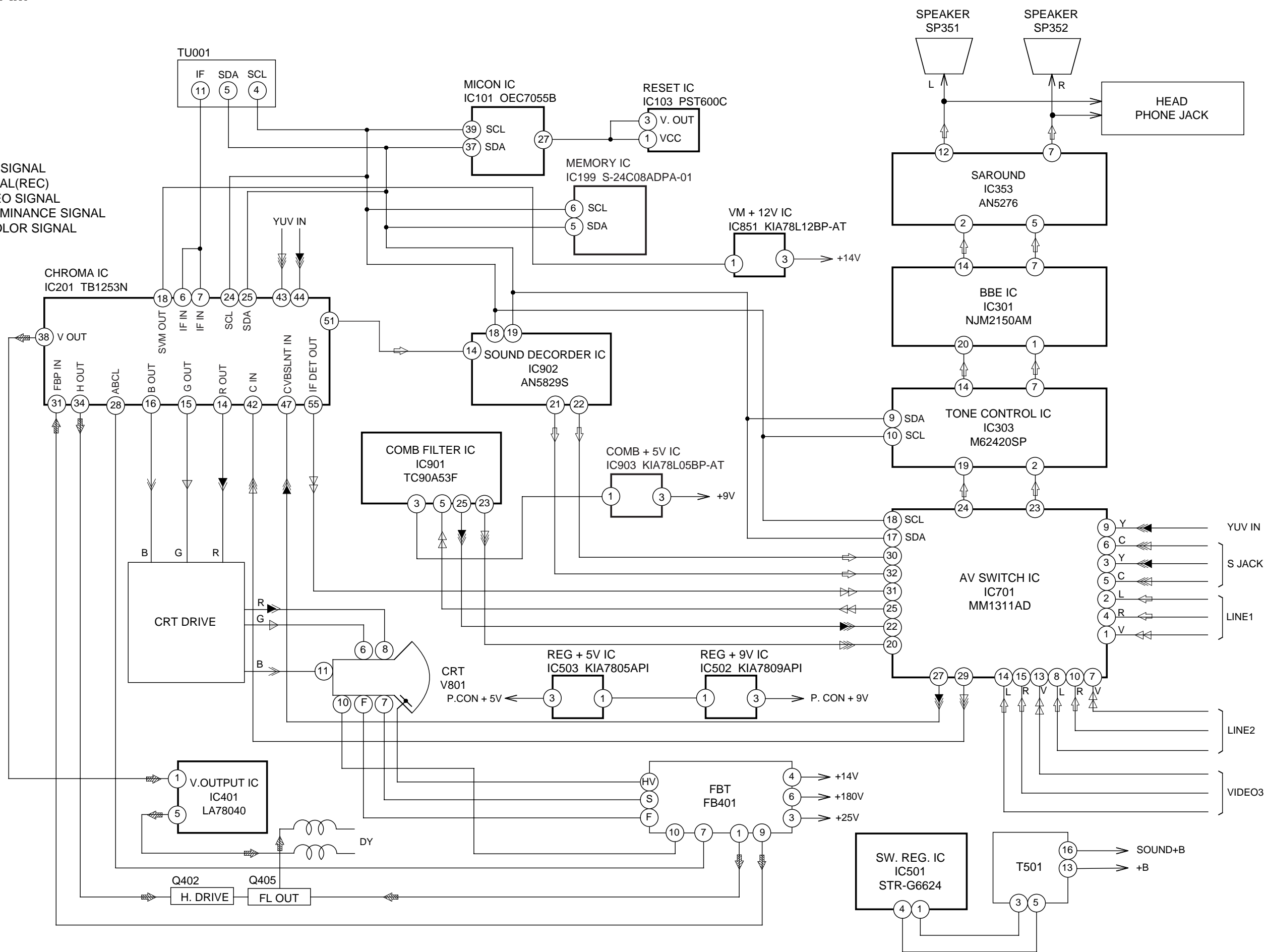

CIRCUIT DIAGRAM [MAIN PCB MICON/TUNER SCHEMATIC DIAGRAM]

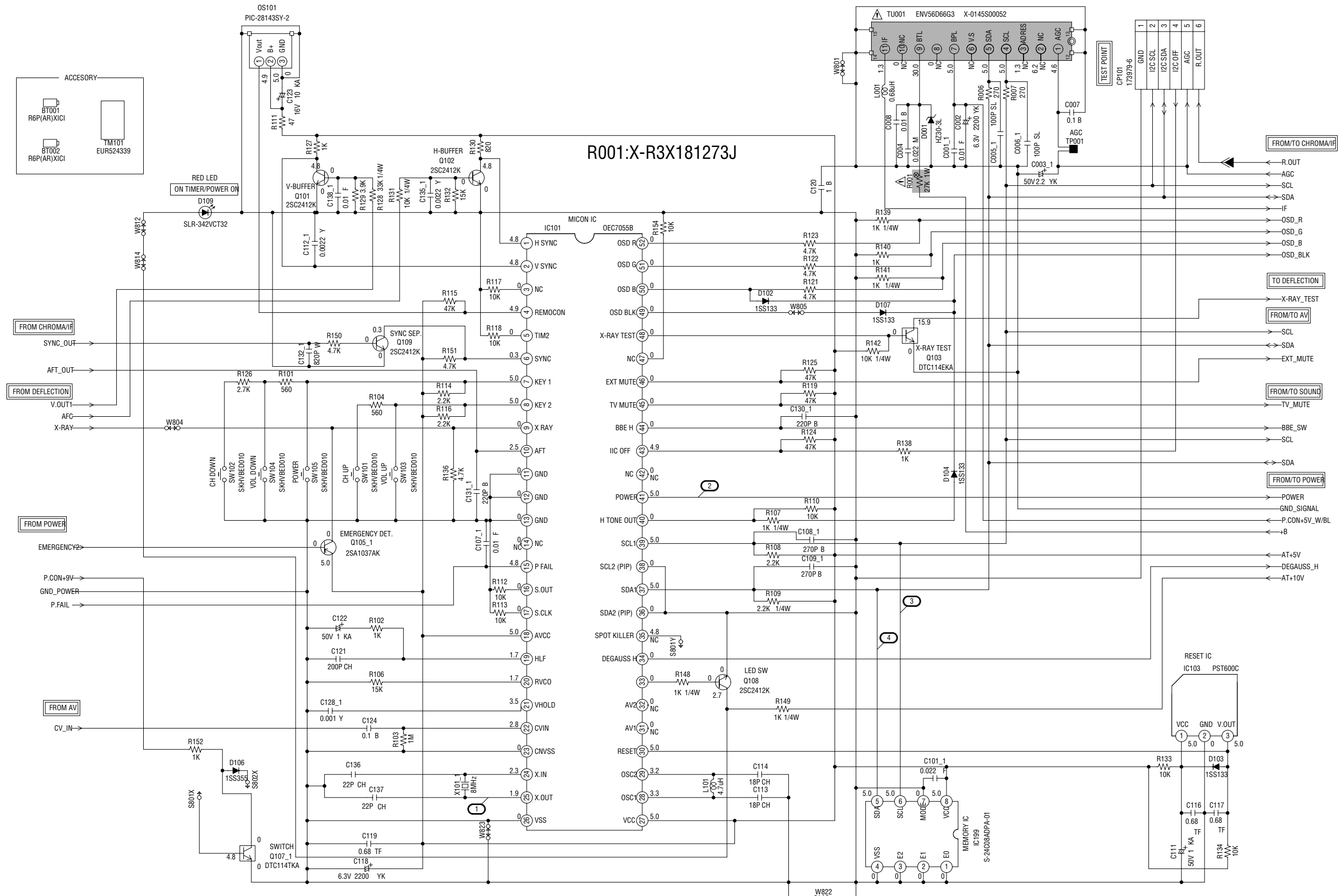

NOTE: THE DC VOLTAGE AT EACH PART WAS MEASURED WITH THE DIGITAL TESTER WHEN THE COLOR BROADCAST WAS RECEIVED IN GOOD CONDITION AND PICTURE IS NORMAL.

NOTE: THIS SCHEMATIC DIAGRAM IS THE LATEST AT THE TIME OF PRINTING AND SUBJECT TO CHANGE WITHOUT NOTICE.

CAUTION: SINCE THESE PARTS MARKED BY ARE CRITICAL FOR SAFETY, USE ONES DESCRIBED IN PARTS LIST ONLY.

ATTENTION: LES PIECES REPARÉES PAR UN ÉTANT DANGEREUSES AN POINT DE VUE SECURITE N'UTILISER QUE CELLS DECRITES DANS LA NOMENCLATURE DES PIECES.

CAUTION: DIGITAL TRANSISTOR

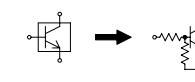

R.SIGNAL

【 MAIN PCB CHROMA/IF SCHEMATIC DIAGRAM 】

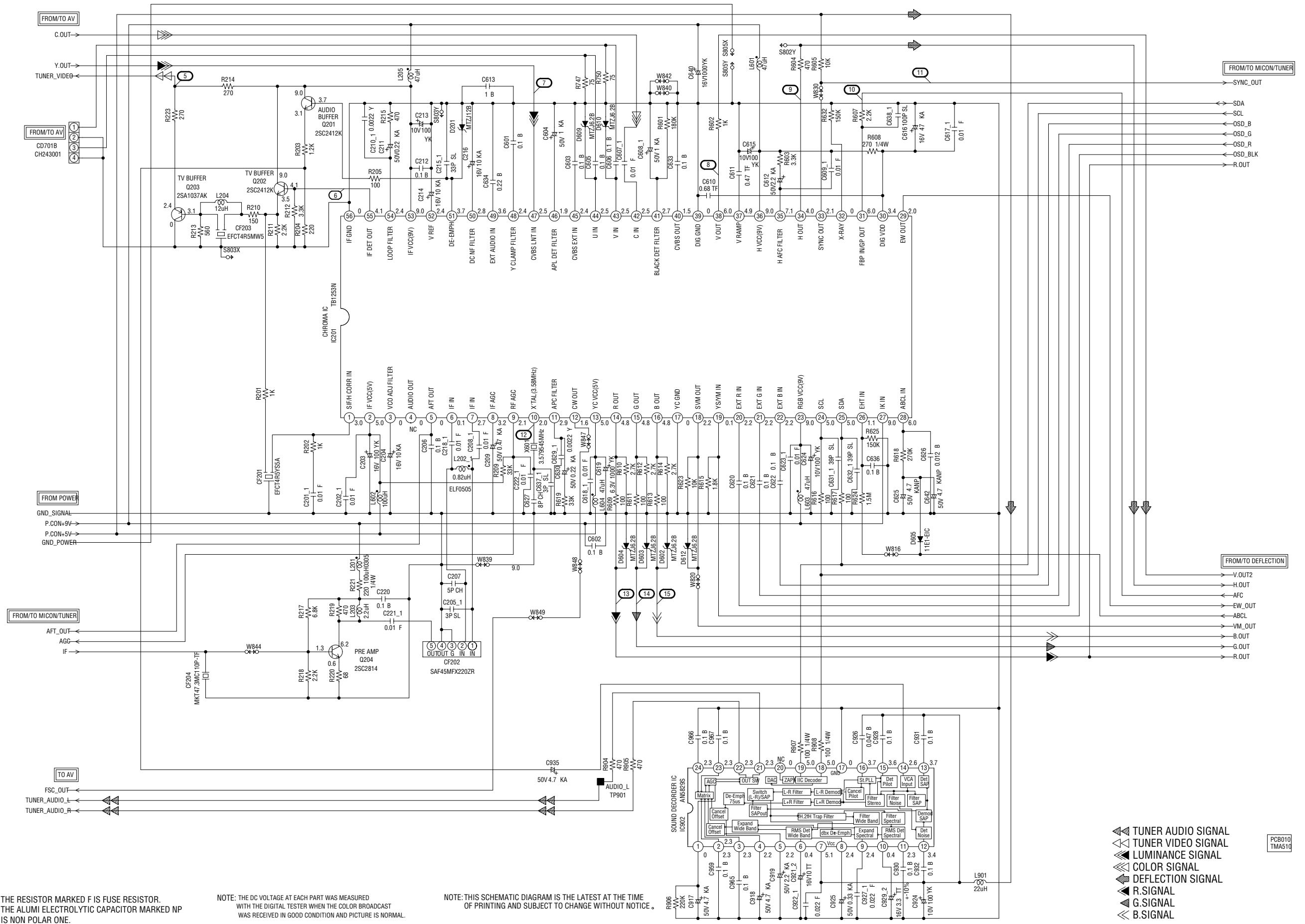

NOTE: THE RESISTOR MARKED F IS FUSE RESISTOR.
THE ALUMI ELECTROLYTIC CAPACITOR MARKED NP IS NON POLAR ONE.

NOTE: THE DC VOLTAGE AT EACH PART WAS MEASURED WITH THE DIGITAL TESTER WHEN THE COLOR BROADCAST WAS RECEIVED IN GOOD CONDITION AND PICTURE IS NORMAL.

NOTE: THIS SCHEMATIC DIAGRAM IS THE LATEST AT THE TIME OF PRINTING AND SUBJECT TO CHANGE WITHOUT NOTICE.

- ▶ TUNER AUDIO SIGNAL
- ▶ TUNER VIDEO SIGNAL
- ▶ LUMINANCE SIGNAL
- ▶ COLOR SIGNAL
- ▶ DEFLECTION SIGNAL
- ▶ R.SIGNAL
- ▶ G.SIGNAL
- ▶ B.SIGNAL

PC8010
TMA514

【 MAIN PCB DEF DIAGRAM 】

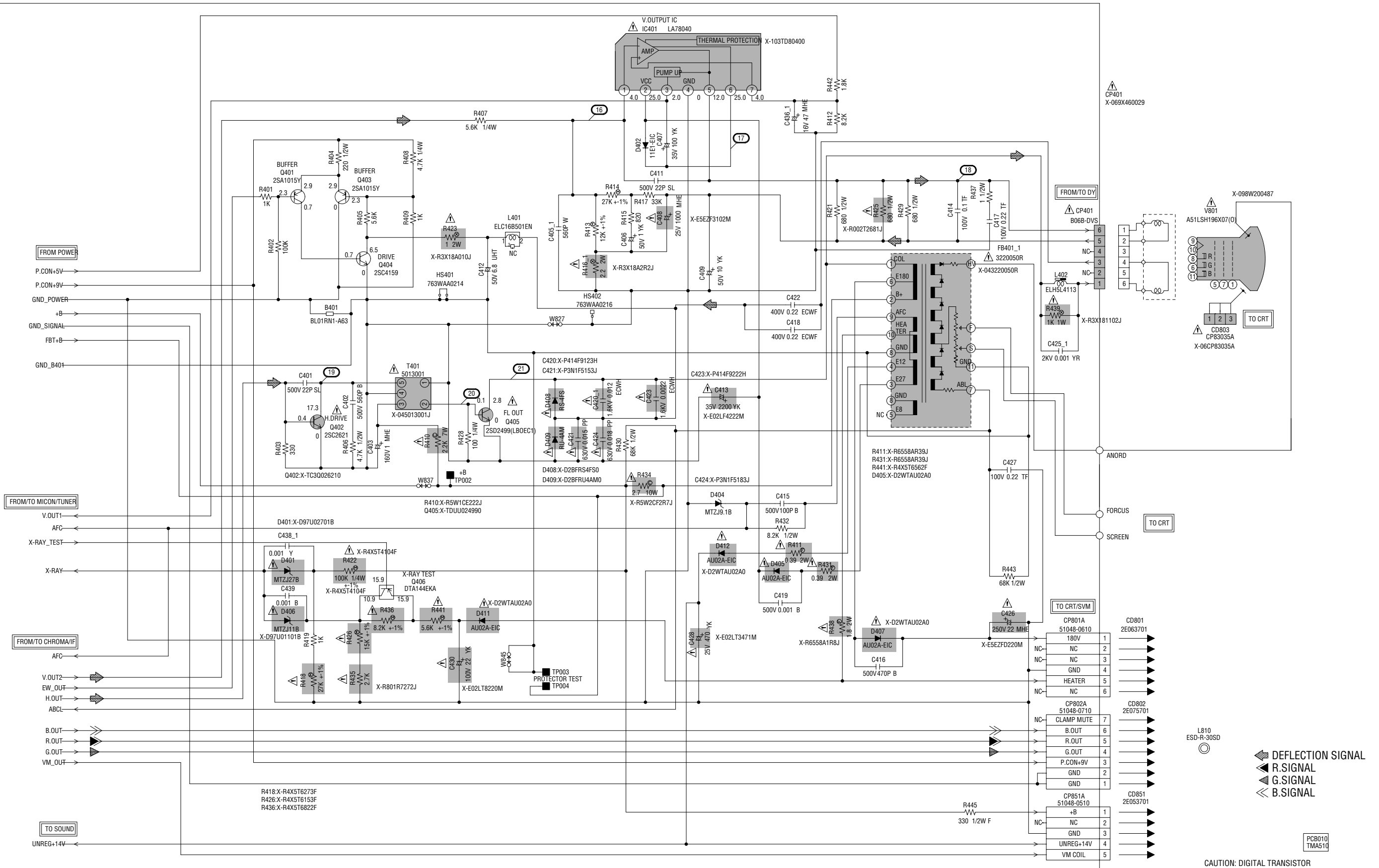

NOTE: THE DC VOLTAGE AT EACH PART WAS MEASURED WITH THE DIGITAL TESTER WHEN THE COLOR BROADCAST WAS RECEIVED IN GOOD CONDITION AND PICTURE IS NORMAL.

NOTE: THIS SCHEMATIC DIAGRAM IS THE LATEST AT THE TIME OF PRINTING AND SUBJECT TO CHANGE WITHOUT NOTICE.

CAUTION: SINCE THESE PARTS MARKED BY Δ ARE CRITICAL FOR SAFETY, USE ONES DESCRIBED IN PARTS LIST ONLY.

ATTENTION: LES PIÈCES RÉPARÉES PAR UN Δ ÉTANT DANGEREUSES AU POINT DE VUE SÉCURITÉ N'UTILISER QUE CELLES DÉCRITES DANS LA NOMENCLATURE DES PIÈCES.

NOTE: THE RESISTOR MARKED F IS FUSE RESISTOR. THE ALUMI ELECTROLYTIC CAPACITOR MARKED NP IS NON POLAR ONE.



CAUTION: DIGITAL TRANSISTOR

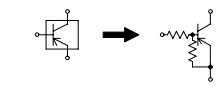

【 MAIN PCB POWER CIRCUIT DIAGRAM 】



CAUTION: FOR CONTINUED PROTECTION AGAINST FIRE HAZARD, REPLACE ONLY WITH THE SAME TYPE FUSE 6.3A 125V(F501)

ATTENTION: POUR UNE PROTECTION CONTINUE LES RISQUES D'INCEINDE N'UTILISER QUE DES FUSIBLE DE MEME TYPE 6.3A 125V(F501)

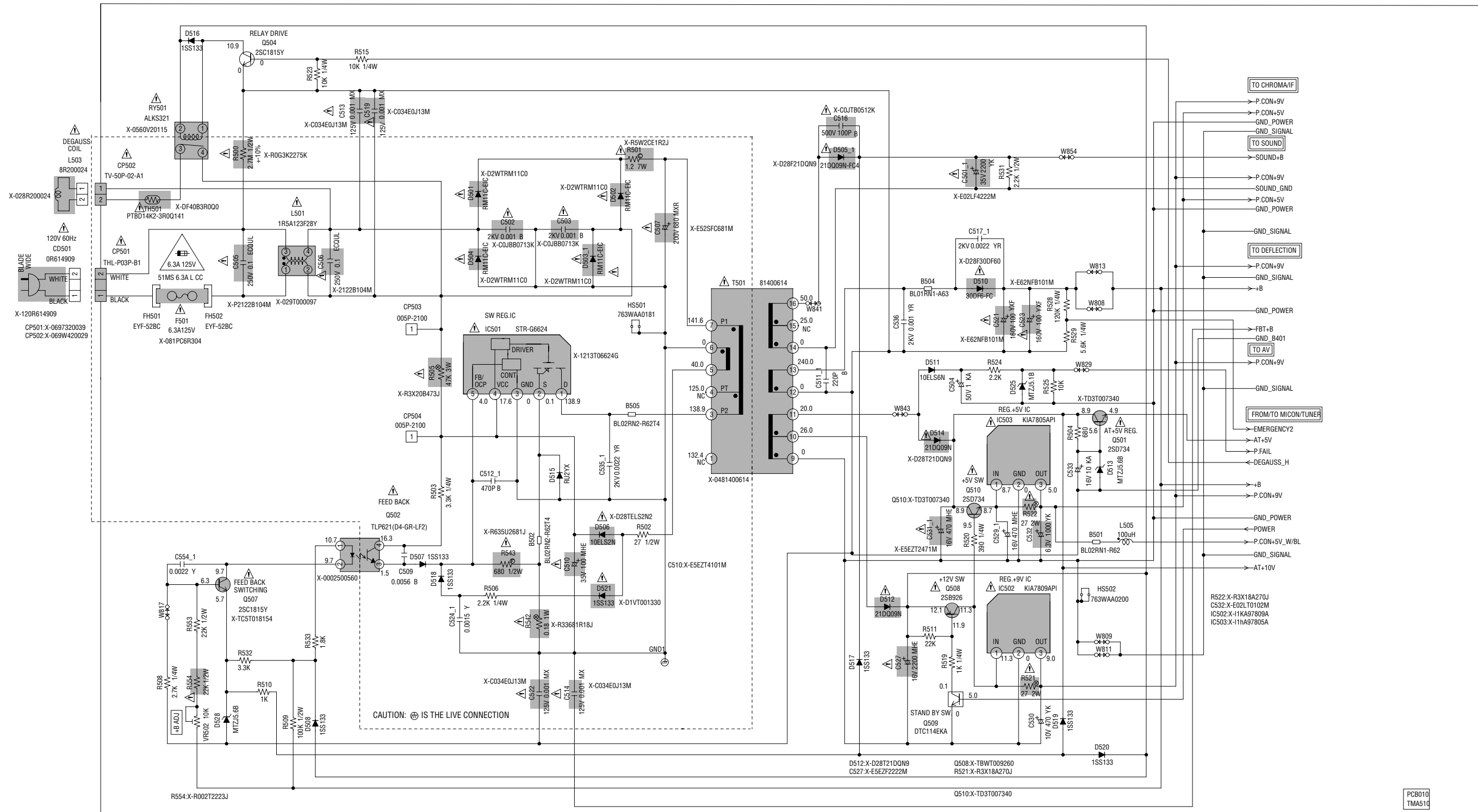

NOTE: THE DC VOLTAGE AT EACH PART WAS MEASURED WITH THE DIGITAL TESTER WHEN THE COLOR BROADCAST WAS RECEIVED IN GOOD CONDITION AND PICTURE IS NORMAL.

NOTE: THIS SCHEMATIC DIAGRAM IS THE LATEST AT THE TIME OF PRINTING AND SUBJECT TO CHANGE WITHOUT NOTICE.

CAUTION: SINCE THESE PARTS MARKED BY ARE CRITICAL FOR SAFETY, USE ONES DESCRIBED IN PARTS LIST ONLY.

ATTENTION: LES PIECES REPARÉES PAR UN ÉTANT DANGEREUSES AN POINT DE VUE SECURITE N'UTILISER QUE CELLS DECRITES DANS LA NOMENCLATURE DES PIECES,

NOTE: THE RESISTOR MARKED F IS FUSE RESISTOR. THE ALUMI ELECTROLYTIC CAPACITOR MARKED NP IS NON POLAR ONE.

CAUTION: DIGITAL TRANSISTOR



PCB010 TMA51C

【 MAIN PCB SOUND CIRCUIT DIAGRAM 】

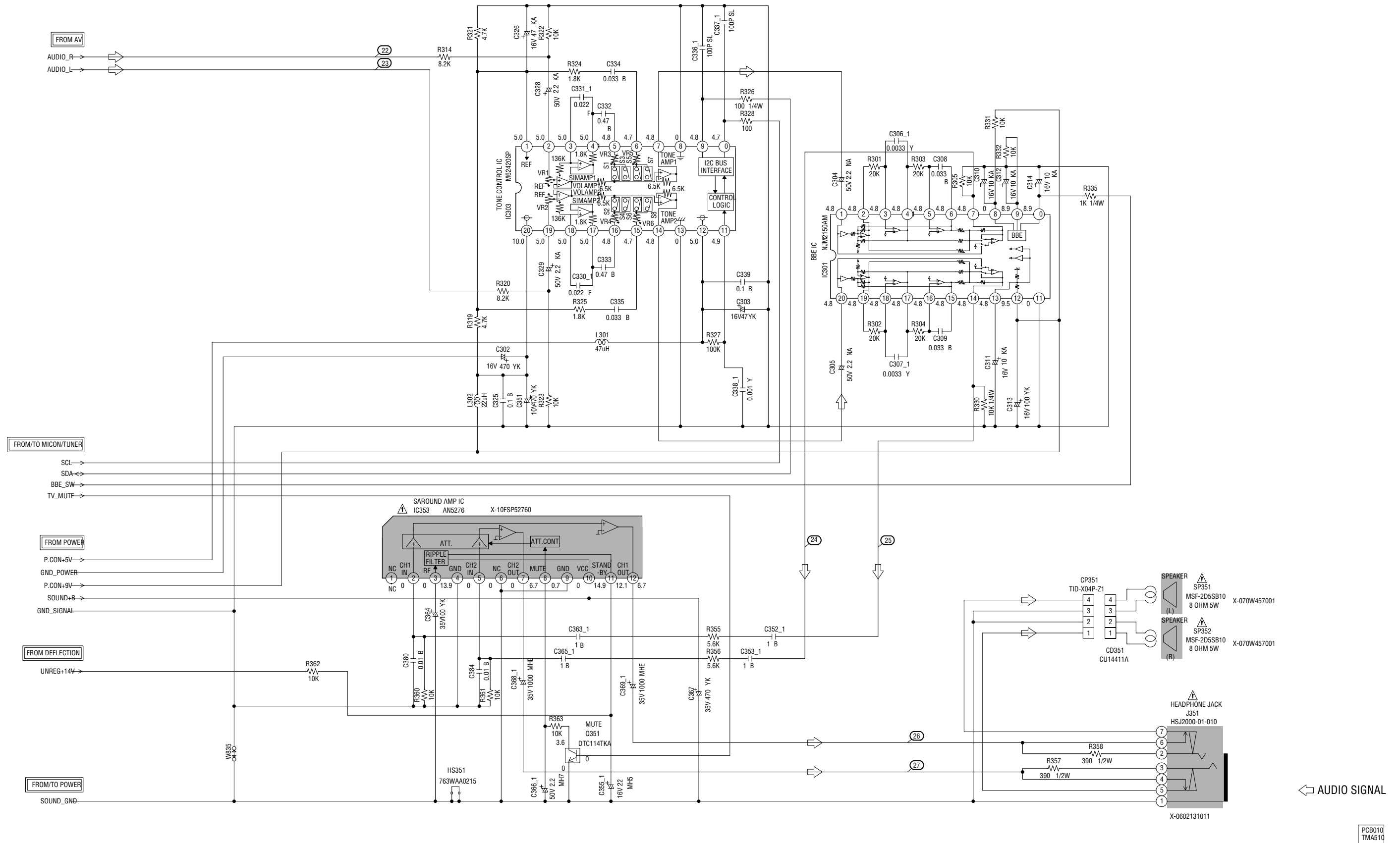

NOTE: THE DC VOLTAGE AT EACH PART WAS MEASURED WITH THE DIGITAL TESTER WHEN THE COLOR BROADCAST WAS RECEIVED IN GOOD CONDITION AND PICTURE IS NORMAL.

NOTE: THIS SCHEMATIC DIAGRAM IS THE LATEST AT THE TIME OF PRINTING AND SUBJECT TO CHANGE WITHOUT NOTICE.

CAUTION: SINCE THESE PARTS MARKED BY ARE CRITICAL FOR SAFETY, USE ONES DESCRIBED IN PARTS LIST ONLY.

ATTENTION: LES PIECES REPARÉES PAR UN ÉTANT DANGEREUSES AN POINT DE VUE SECURITE N'UTILISER QUE CELLS DÉCRITES DANS LA NOMENCLATURE DES PIECES.

NOTE: THE RESISTOR MARKED F IS FUSE RESISTOR. THE ALUMI ELECTROLYTIC CAPACITOR MARKED NP IS NON POLAR ONE.

CAUTION: DIGITAL TRANSISTOR

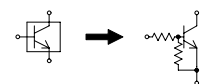

← AUDIO SIGNAL

【 MAIN PCB AV CIRCUIT DIAGRAM 】

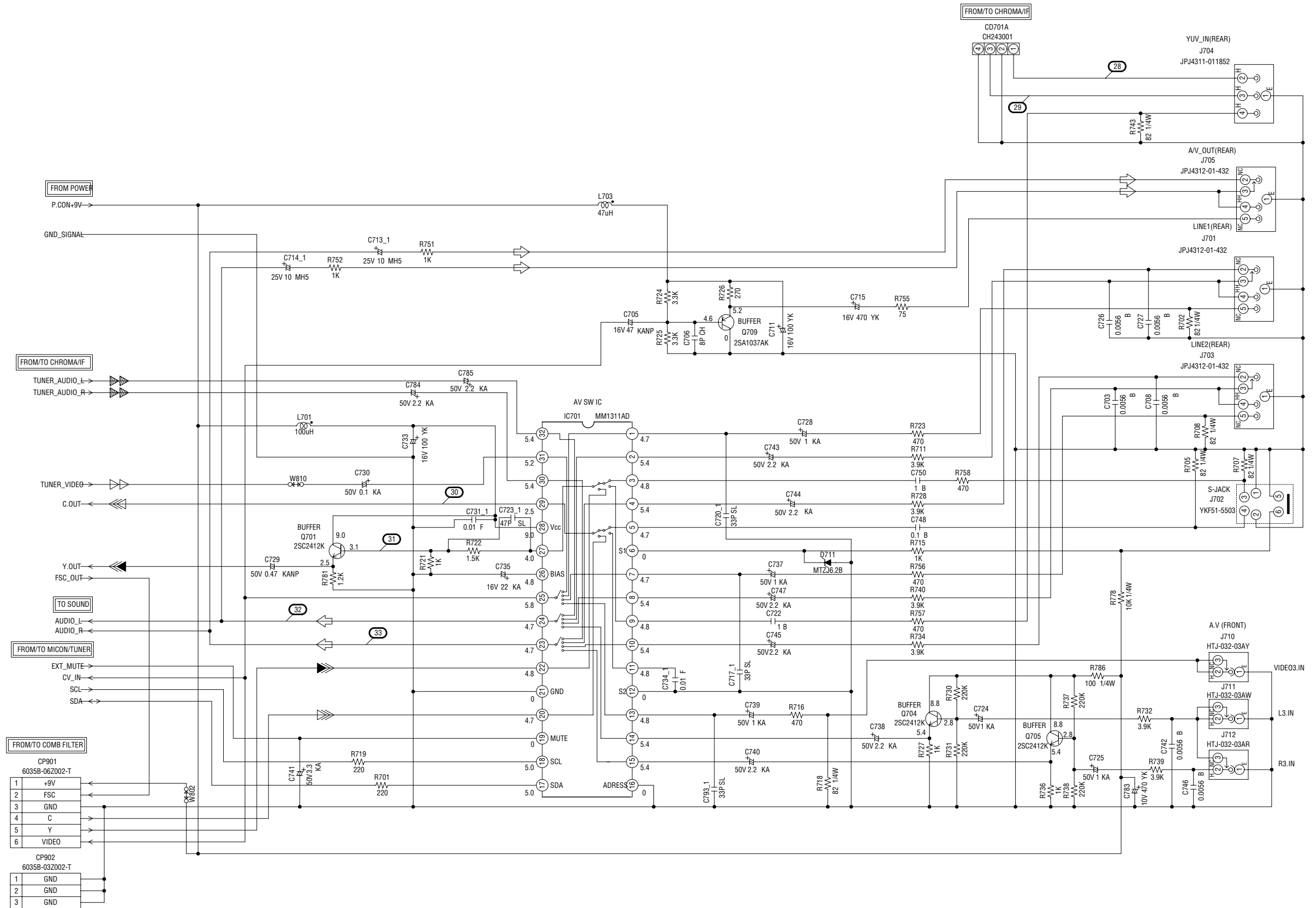

NOTE: THE DC VOLTAGE AT EACH PART WAS MEASURED WITH THE DIGITAL TESTER WHEN THE COLOR BROADCAST WAS RECEIVED IN GOOD CONDITION AND PICTURE IS NORMAL.

NOTE: THIS SCHEMATIC DIAGRAM IS THE LATEST AT THE TIME OF PRINTING AND SUBJECT TO CHANGE WITHOUT NOTICE.

CAUTION: DIGITAL TRANSISTOR

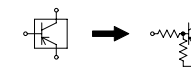

- ◀ AUDIO SIGNAL
- ▶ TUNER AUDIO SIGNAL
- ▶ TUNER VIDEO SIGNAL
- ▶ COLOR SIGNAL
- ▶ LUMINANCE SIGNAL

PCB010
TMA510

【 COMB FILTER PCB CIRCUIT DIAGRAM 】

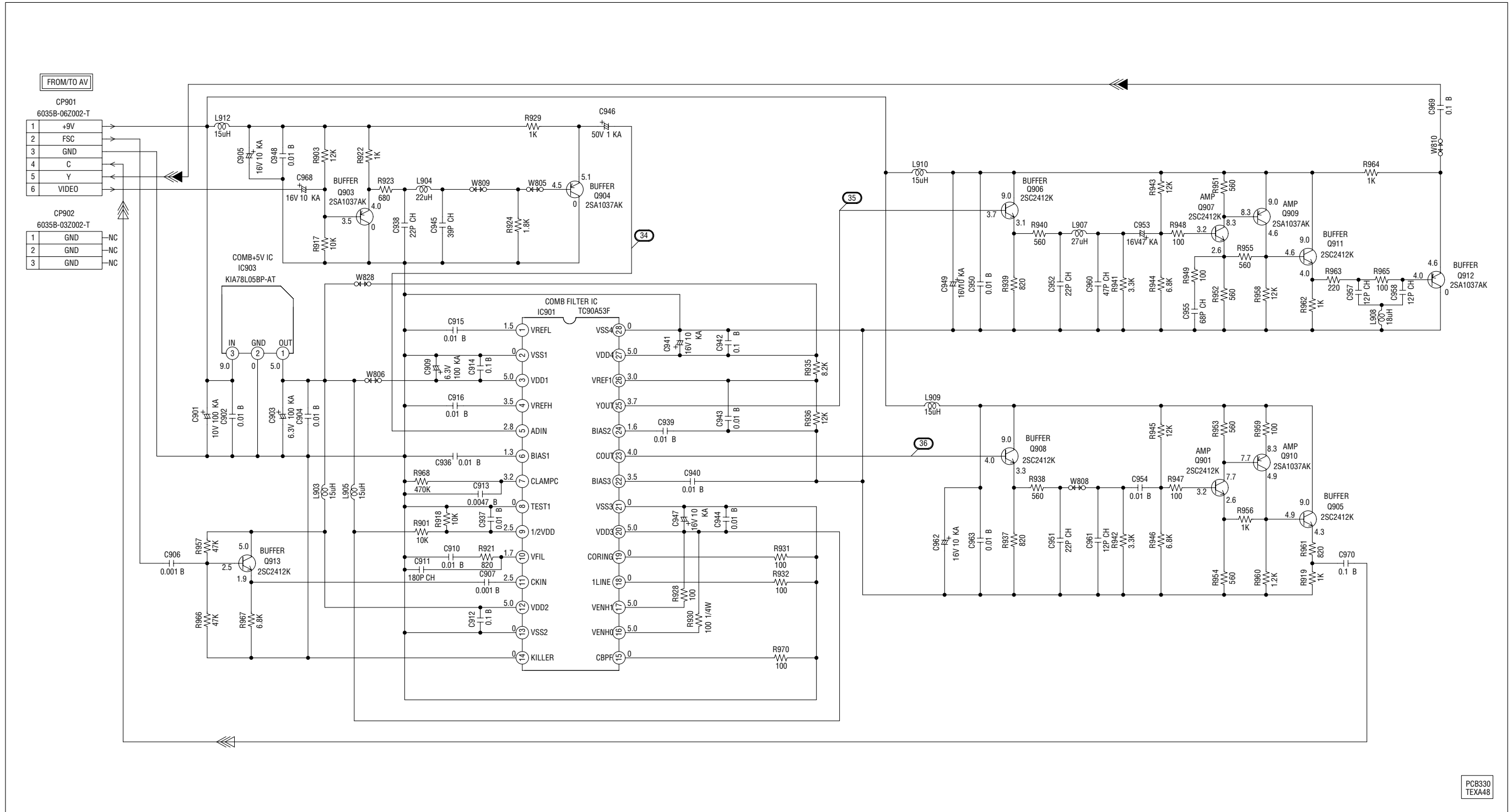

NOTE: THE DC VOLTAGE AT EACH PART WAS MEASURED WITH THE DIGITAL TESTER WHEN THE COLOR BROADCAST WAS RECEIVED IN GOOD CONDITION AND PICTURE IS NORMAL.

NOTE: THIS SCHEMATIC DIAGRAM IS THE LATEST AT THE TIME OF PRINTING AND SUBJECT TO CHANGE WITHOUT NOTICE.

◀ LUMINANCE SIGNAL
◄ COLOR SIGNAL

【 CRT/VM PCB CIRCUIT DIAGRAM 】

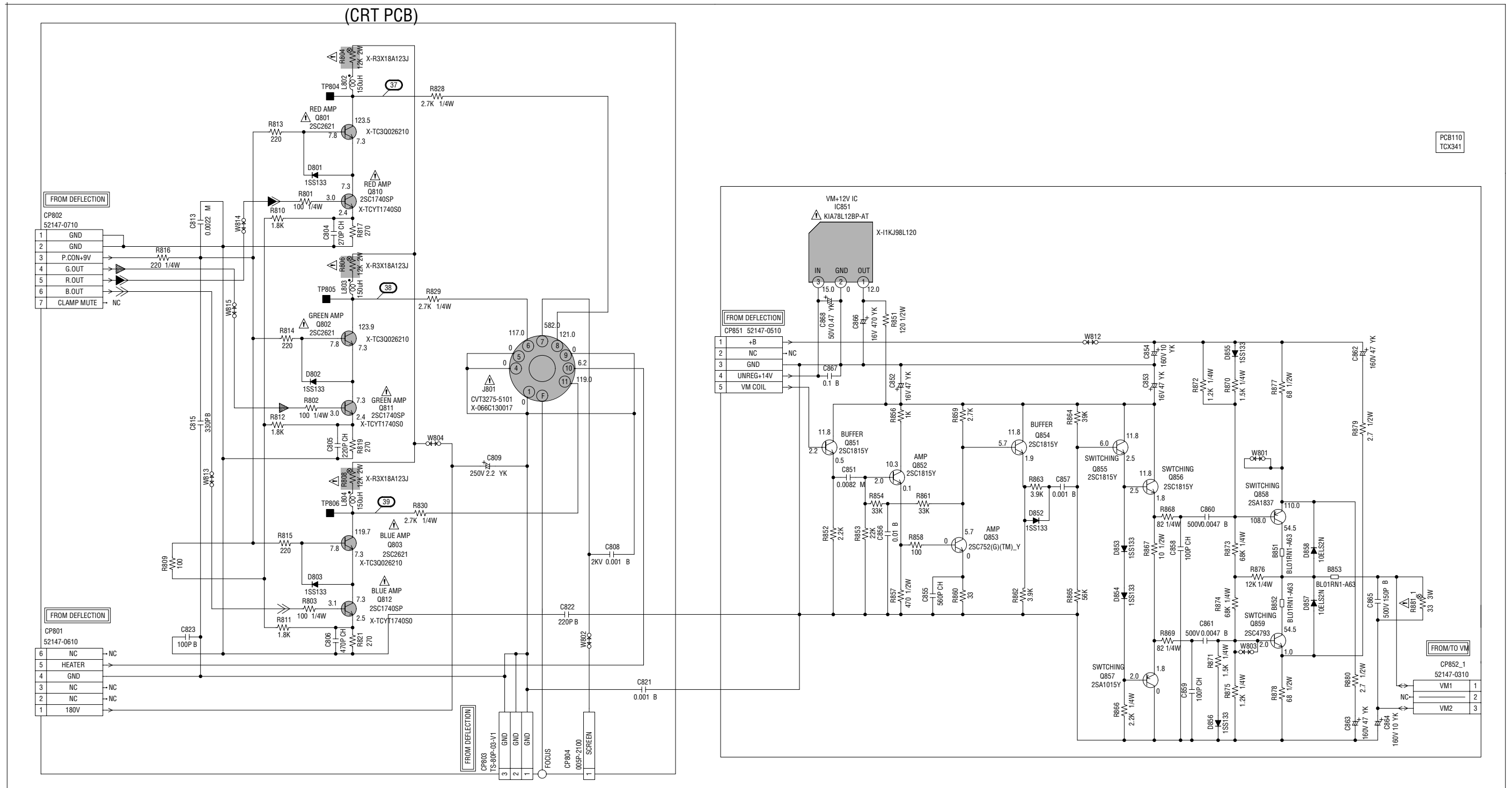

PCB110
TCX341

FROM/TO VM
CP852_1
52147-0310
VM1 1
VM2 3

NOTE: THE DC VOLTAGE AT EACH PART WAS MEASURED WITH THE DIGITAL TESTER WHEN THE COLOR BROADCAST WAS RECEIVED IN GOOD CONDITION AND PICTURE IS NORMAL.

NOTE: THIS SCHEMATIC DIAGRAM IS THE LATEST AT THE TIME OF PRINTING AND SUBJECT TO CHANGE WITHOUT NOTICE.

CAUTION: SINCE THESE PARTS MARKED BY ARE CRITICAL FOR SAFETY, USE ONES DESCRIBED IN PARTS LIST ONLY.

ATTENTION: LES PIECES REPARÉES PAR UN ÉTANT DANGEREUSES AN POINT DE VUE SECURITE N'UTILISER QUE CELLS DECRITES DANS LA NOMENCLATURE DES PIECES.

R.SIGNAL
 G.SIGNAL
 B.SIGNAL

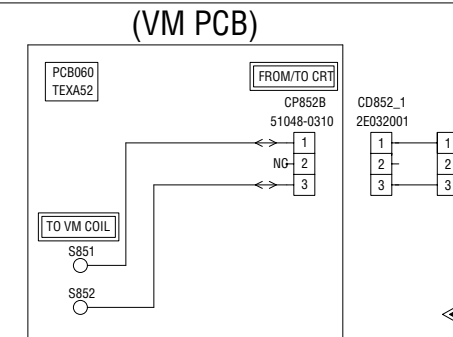

PATTERN DIAGRAM

[MAIN PCB PATTERN (INSERTED PARTS)]

PRINTED CIRCUIT BOARDS
MAIN (INSERTED PARTS)
SOLDER SIDE

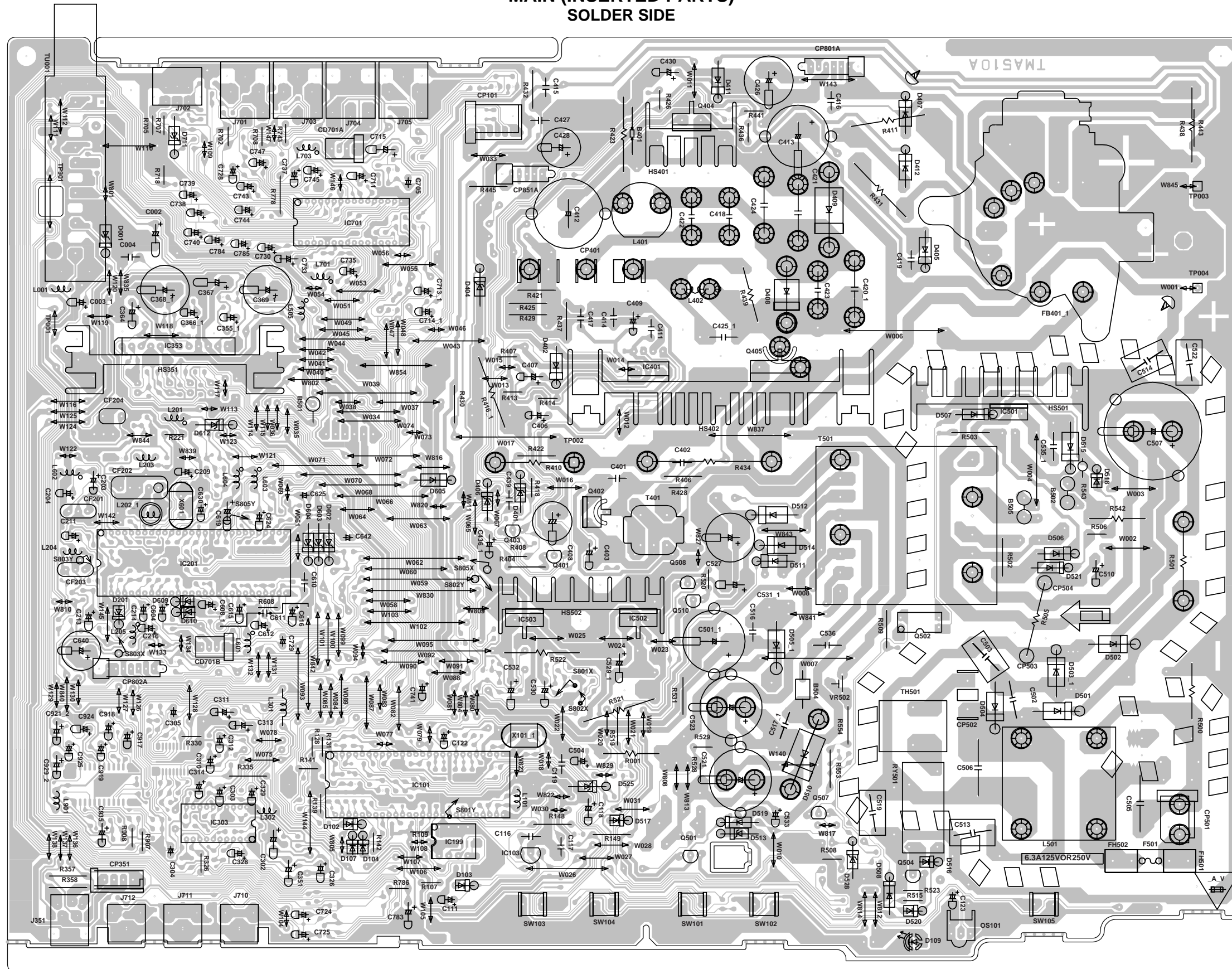

【 MAIN PCB PATTERN (CHIP MOUNTED PARTS) 】

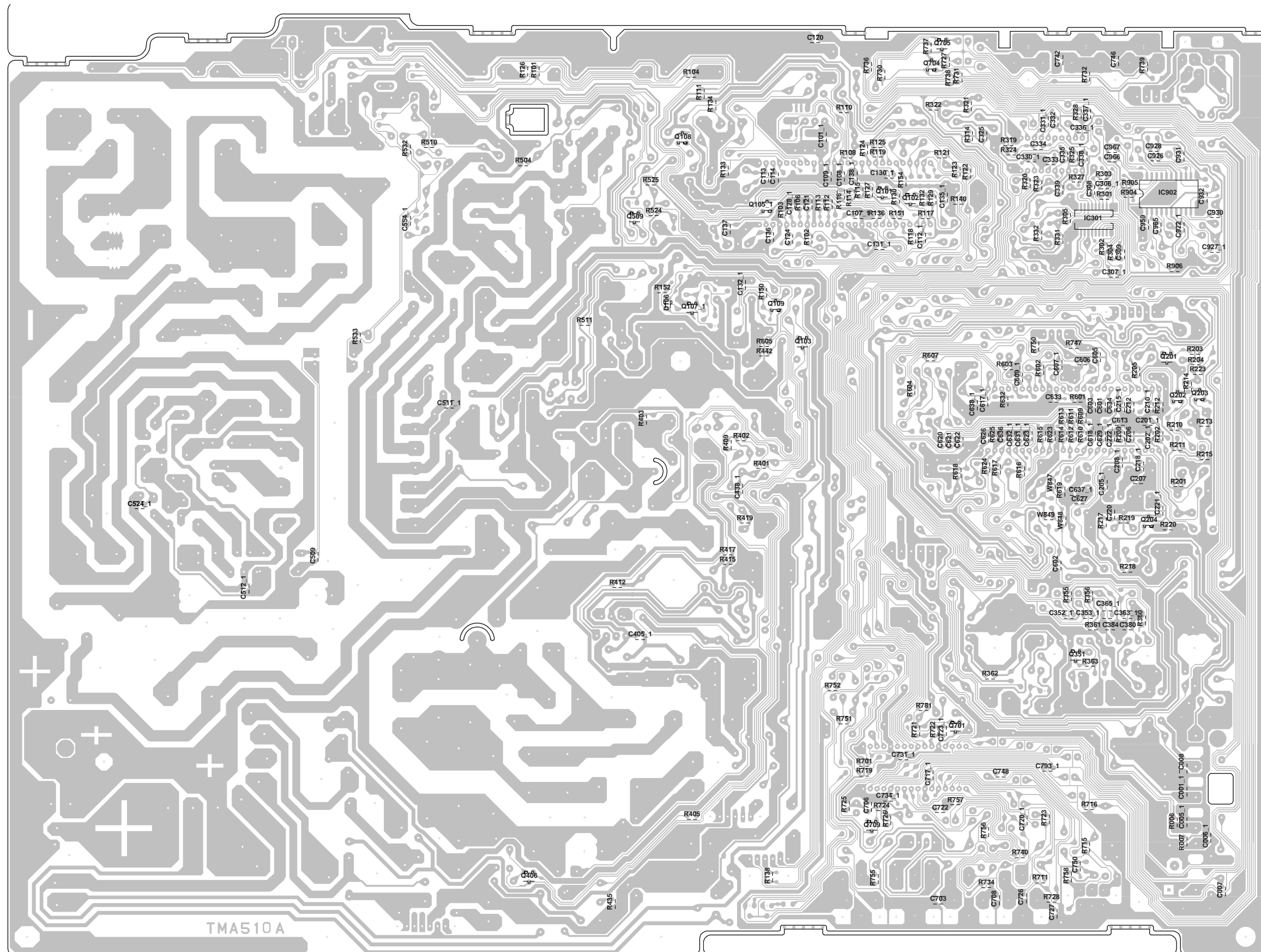
PRINTED CIRCUIT BOARDS
MAIN (CHIP MOUNTED PARTS)
SOLDER SIDE

[COMB PCB PATTERN]

COMB (INSERTED PARTS)
SOLDER SIDE

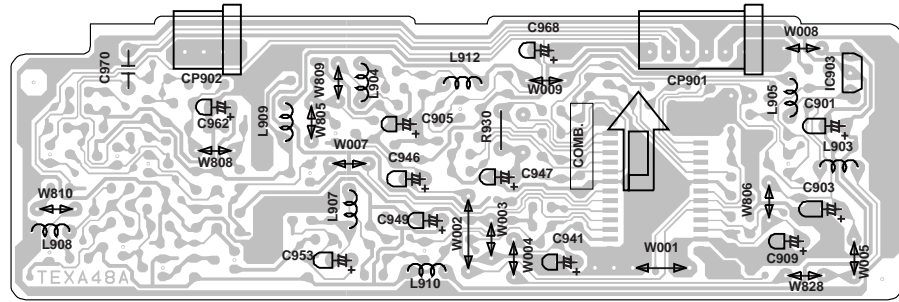

[CRT/VM PCB PATTERN]

CRT/VM (INSERTED PARTS)
SOLDER SIDE

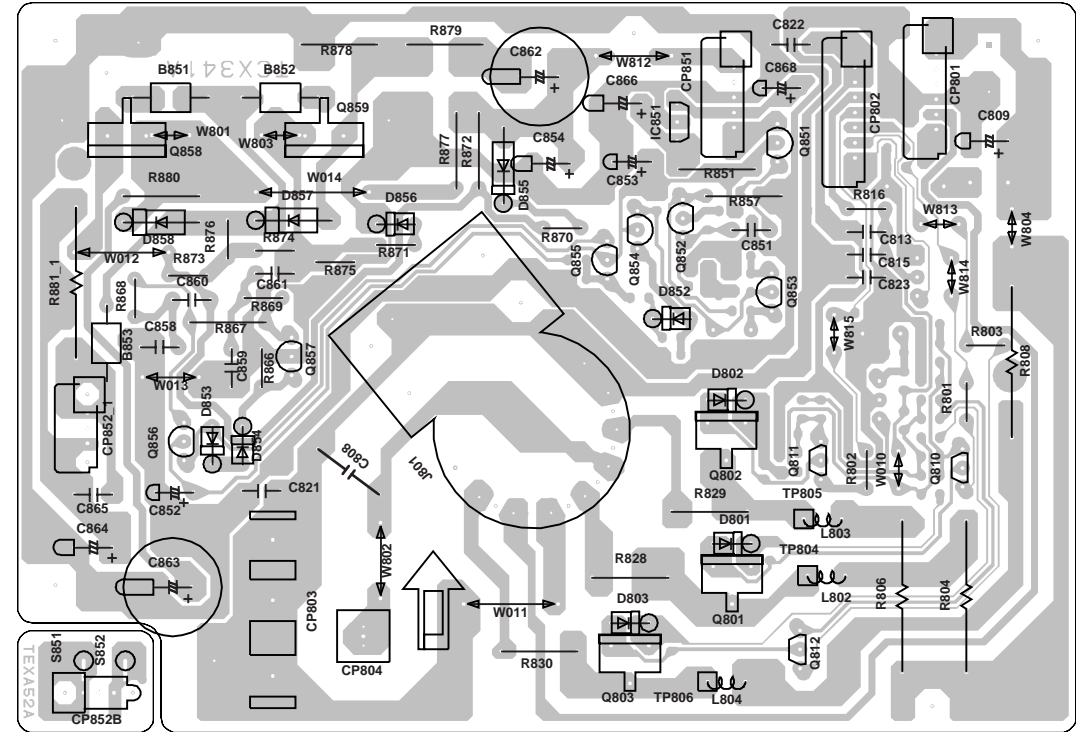

COMB (CHIP MOUNTED PARTS)
SOLDER SIDE

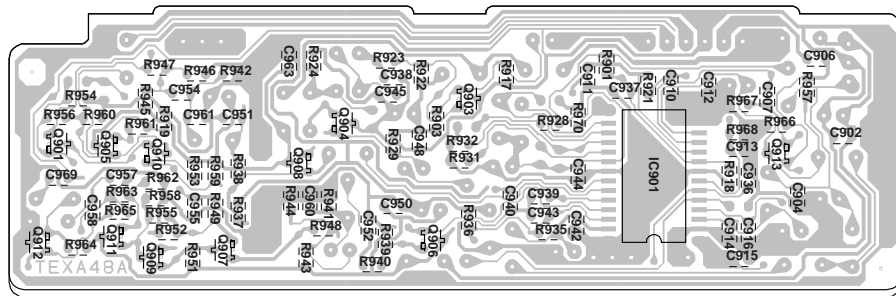

CRT (CHIP MOUNTED PARTS)
SOLDER SIDE

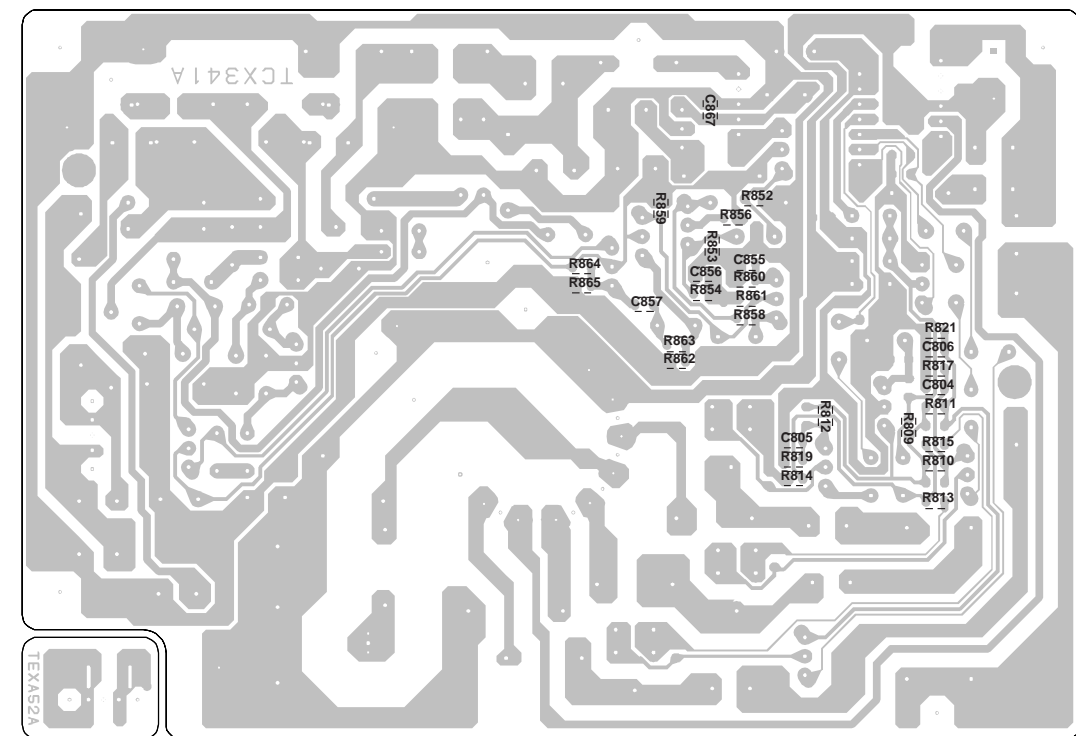

WAVEFORMS

MICON/TUNER

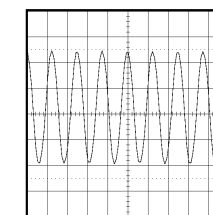

① 1V 0.1μs/div

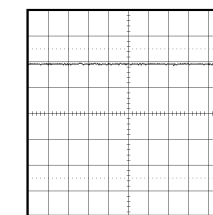

② 1V 1μs/div

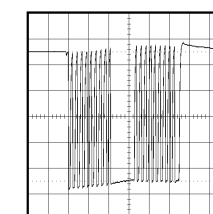

③ 1V 50μs/div

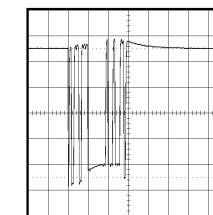

④ 1V 0.1ms/div

CHROMA/IF

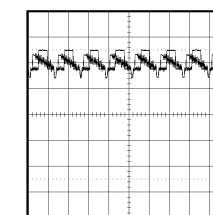

⑤ 1V 50μs/div

WAVEFORMS

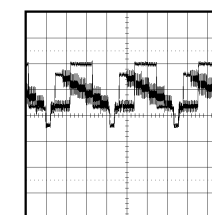

⑥ 1V 20μs/div

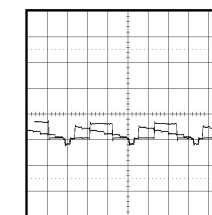

⑦ 1V 20μs/div

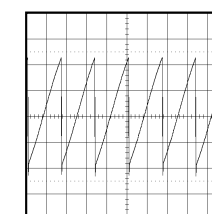

⑧ 0.5V 10ms/div

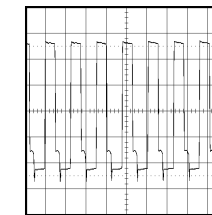

⑨ 1V 50μs/div

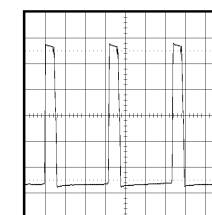

⑩ 2V 20μs/div

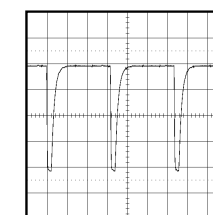

⑪ 0.5V 20μs/div

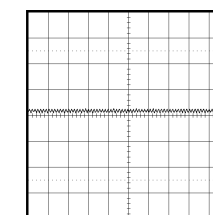

⑫ 1V 2μs/div

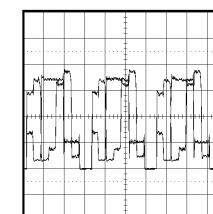

⑬ 1V 20μs/div

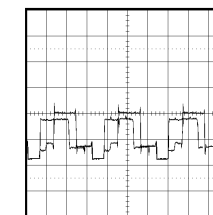

⑭ 2V 20μs/div

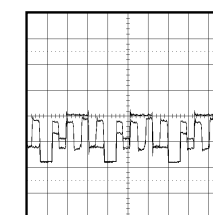

⑮ 2V 20μs/div

NOTE: The following waveforms were measured at the point of the corresponding balloon number in the schematic diagram.

WAVEFORMS

DEFLECTION

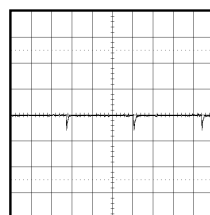

16 2V 5ms/div

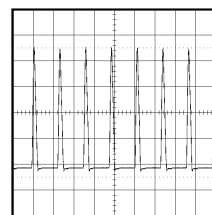

21 200V 50μs/div

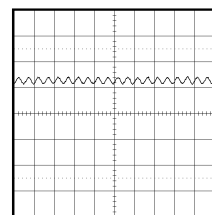

26 5V 2ms/div

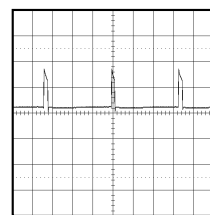

17 20V 5ms/div

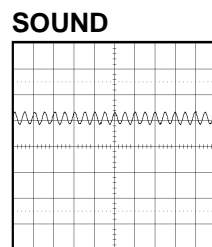

22 2V 5ms/div

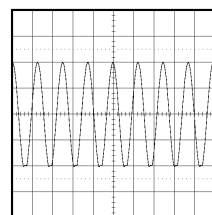

27 5V 2ms/div

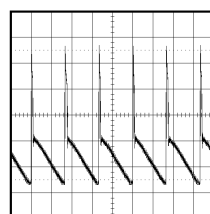

18 10V 10ms/div

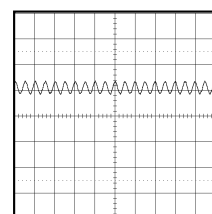

23 2V 5ms/div

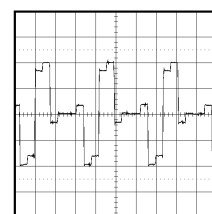

28 200mV 20μs/div

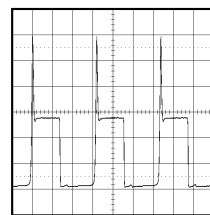

19 20V 20μs/div

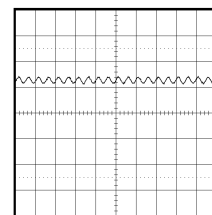

24 2V 5ms/div

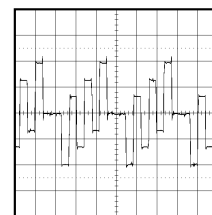

29 200mV 20μs/div

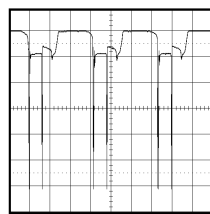

20 2V 20μs/div

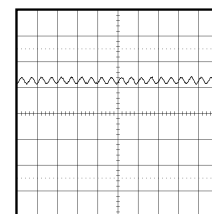

25 2V 5ms/div

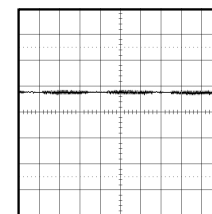

30 2V 20μs/div

NOTE: The following waveforms were measured at the point of the corresponding balloon number in the schematic diagram.

WAVEFORMS

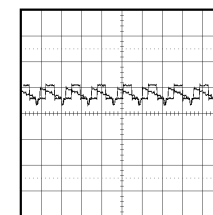

31 1V 50μs/div

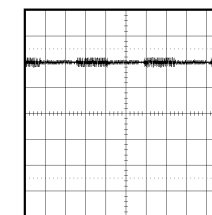

36 1V 5ms/div

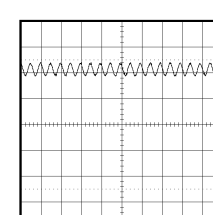

32 2V 5ms/div

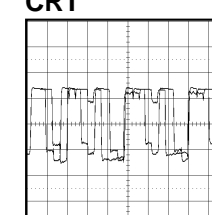

37 50V 20μs/div

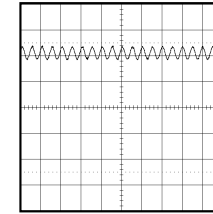

33 2V 5ms/div

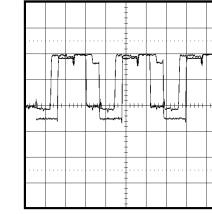

38 50V 20μs/div

COMB FILTER

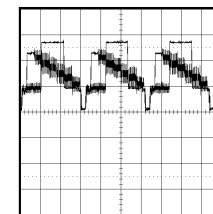

34 0.5V 20μs/div

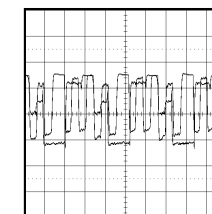

39 50V 20μs/div

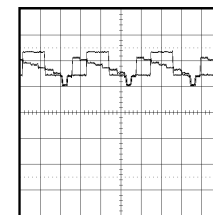

35 1V 20μs/div

NOTE: The following waveforms were measured at the point of the corresponding balloon number in the schematic diagram.